



For wheelchairs, bicycles and goods deliveries

MPG swing gates are the optimum solution for outdoor barriers when a large passage opening is necessary. It can be free-standing or used in combination with a MPT turnstile. The swing gate has an opening angle of 90° in both directions and can be controlled by all conventional access control systems. As an option, the swing gate can be expanded with a single- or double-sided induction loop that reliably detects the presence of bicycles and wheelchairs.

The swing gate is energy-efficient, maintenance-free and quiet thanks to its MHTM™ drive technology. Low impact forces and sensitive contact detection ensure user safety and compliance with strict European standards. With a variety of material options, interlocks and supplementary attachments, MPG swing gates can be individually adapted to the desired purpose.



For wheelchairs, bicycles and baggage

MPG swing gates are the optimum solution when large opening widths are necessary. A wide variety of options are available for access control.



Innovative drive technology

The MHTM™ drive unit is maintenance-free, energy-efficient, and has an exceptional soft-start action.

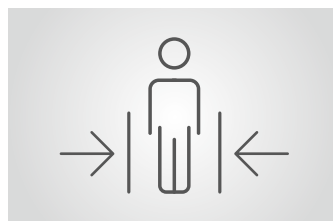

Maximum safety

Low impact forces and sensitive contact detection offer optimum protection for persons and their means of locomotion.



Easy access to components

All the components necessary for operation are accommodated in the main beams, considerably simplifying assembly, commissioning and maintenance.

MPG

Wheelchair-Accessible Swing Gate

- > Controlled access for cyclists and wheelchair users
- > Sensitive impact detection for maximum safety
- > Induction loop sensor for detection of bicycles and wheelchairs (optional)
- > Low electricity consumption thanks to maintenance-free MHTM™ drive
- > Meets European safety standards, e.g. EN 13241



Technical data	MPG 162	MPG 172
Installation	in combination with turnstile system	free-standing
Drive technology	MHTM™	MHTM™
Voltage	110 – 240 VAC, 50/60 Hz	110 – 240 VAC, 50/60 Hz
Power consumption	85 W (incl. interlock)	85 W (incl. interlock)
Duty cycle	100 %	100 %
Opening/closing times	approx. 3 s	approx. 3 s
Passage width	1087 mm	1070 mm
Enclosure rating	IP 43	IP 43
Dimensions (L x W x H)	1451 x 500 (excl. guide bar) x 2235 mm	1623 x 500 (excl. guide bar) x 2235 mm
Weight	approx. 220 kg	approx. 250 kg
Temperature range	-25 to +50°C	-25 to +50°C

Options	
Material	Galvanized steel, powder-coated steel in standard colors, powder-coated steel in special colors, stainless steel 1.4571
Sensors	Single-sided/double-sided induction loop to detect wheelchairs and bicycles
Reaction to power failure	Free access or auto-locking on power failure
Attachments	Illumination, base frame, base mounting set, roof, extension column, gate end display (GED)

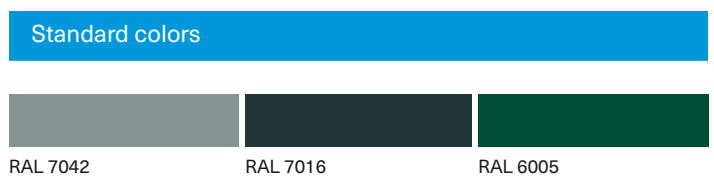
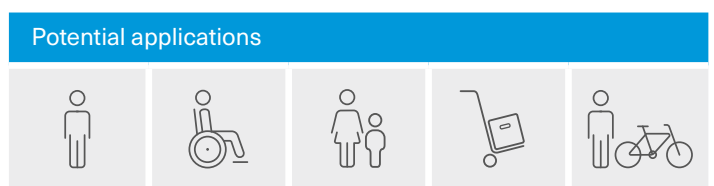

MPG 162
View from inside

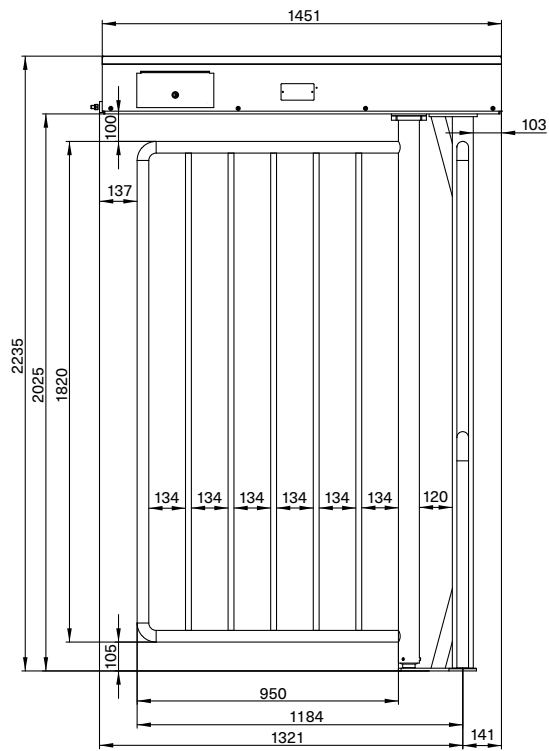

MPG 172
View from inside

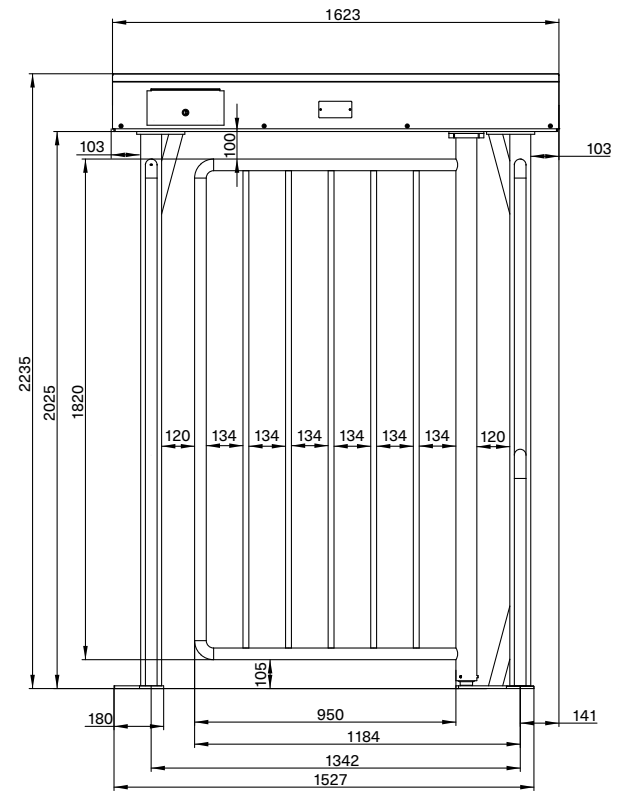

MPG 162 und MPG 172
View from the side

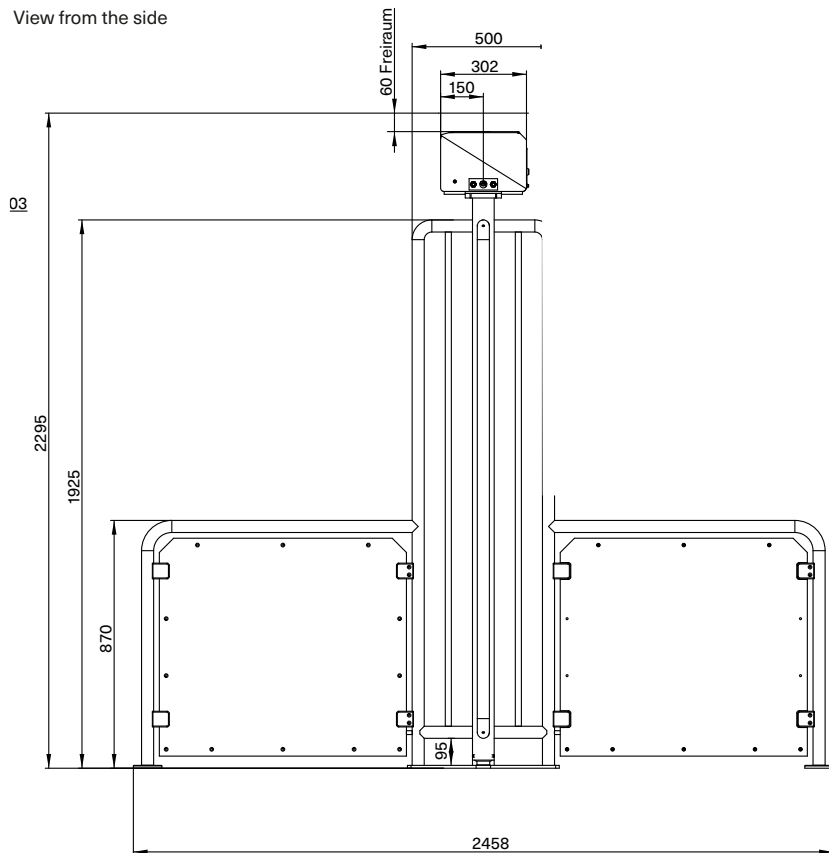

MPG 162
View from below

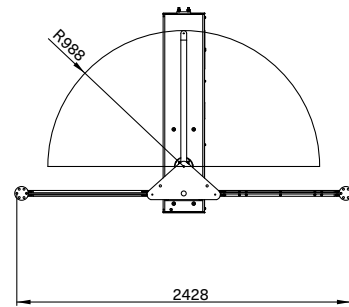

MPG 172
View from below

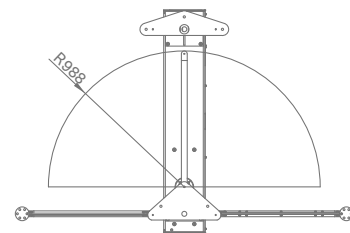

Access to Progress

Magnetic stands for pioneering products – in every way. Our access control systems for vehicles or pedestrians clear the way for thousands of people every day – at car parks, toll gates, stations, airports and in buildings. Our technology is also pioneering, however: with innovative drives, intelligent control systems and well thought-out details it provides maximum safety and longevity. Are you also on the path to Magnetic?

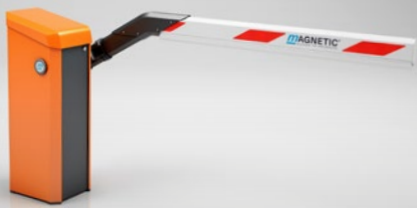

Vehicle barriers

Access barriers
Parking barriers
Toll barriers
Special barriers

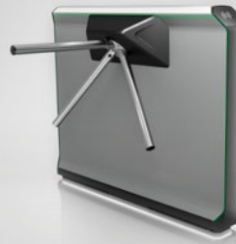

Pedestrian gates

Turnstiles
Swing gates
Tripod gates
Retractable gates
Wing gates



Terminals

Cars
Trucks

Germany
MAGNETIC AUTOCONTROL GMBH
Grienmatt 20
79650 Schopfheim
Phone +49 7622 695-5
Fax +49 7622 695-800
E-mail info@magnetic-germany.com

Australia
MAGNETIC AUTOMATION PTY LTD
38 Metrolink Circuit
Campbellfield, VIC 3061
Phone +61 3 9339 2900
E-mail info@magnetic-oz.com

Austria
FAAC GMBH
Münchner Bundesstraße 123
5020 Salzburg
Phone +43 662 853395-0
E-mail at.info@faacgroup.com

Benelux countries
FAAC BENELUX NV/SA
Industriezone 3B
8490 Jabbeke
Belgium
Phone +32 50 320202
E-mail info@magnetic-benelux.com

Brazil
MAGNETIC AUTOCONTROL LTDA
Av. Salim Antônio Curiati, 136
04690-050 – São Paulo
Phone +55 11 5660 8500
E-mail info@magnetic-br.com

China
MAGNETIC CONTROL SYSTEMS CO., LTD
No. 3 Building, No. 51
Lane 1159, Kang Qiao (East) Road
Kang Qiao Industrial Zone, Shanghai
Phone +86 21 68182970
E-mail info@magnetic-cn.com

France
FAAC FRANCE
377 Rue Ferdinand Perrier
69808 St Priest Cedex
Phone +33 4 72 21 86 89
E-mail info@magnetic-fr.com

India
MAGNETIC AUTOCONTROL PVT LTD.
PRS Centre
Plot No. 373 to 376, 2nd Floor (West Wing)
1st Cross Street, Nehru Nagar
Old Mahabalipuram Road
Kottivakkam (Opp Rayala Technopark, Perungudi)
Chennai 600041
Phone +91 44 421 23297
E-mail info@magnetic-india.com

Middle East
FAAC MIDDLE EAST FZE
Dubai Silicon Oasis
PO Box 54886
Dubai
United Arab Emirates
Phone +971 4 3724193
E-mail info@magnetic-uae.com

N. and S. America (excl. Brazil)
FAAC INTERNATIONAL, INC
3160 Murell Road
Rockledge, FL 32955
USA
Phone +1 321 635 8585
E-mail info@magnetic-usa.com

Scandinavia
FAAC NORDIC AB
Box 125
284 22 Perstorp
Sweden
Phone +46 435 77 95 03
E-mail info@magnetic-nordic.com

Southeast Asia
MAGNETIC CONTROL SYSTEMS SDN. BHD
No. 17, Jalan Anggerik Mokara 31/54
Taman Perindustrian Kota Kemuning
40460 Shah Alam
Selangor Darul Ehsan
Malaysia
Phone +60 3 5123 0033
E-mail info@magnetic-malaysia.com