



### For persons in outdoor areas

MPT turnstiles are the ideal solution for controlling access outdoors when many people are to enter or leave an area in a short time. MPT turnstiles can be precisely adapted to your intended purpose thanks to the drive variants offered: the electric motor-driven MPT 132 turnstile is set in motion by means of an energy-efficient, maintenance-free MHTM™ drive unit – the first choice for representative security for outdoor areas and company grounds. The MPT 33 has an electromechanical interlock unit and the rotary movement is generated by users themselves – a popular variant at leisure parks and stadiums. Both drive versions can be controlled

by means of all conventional access control systems and can be operated in both throughflow directions as an option. The purely mechanical MPT 30 turnstile only lets visitors pass in one direction and is thus particularly suitable for unmonitored exits at swimming pools and sports facilities. MPT turnstiles can also be individually adapted to your requirements in other ways: with a variety of material options, interlock variants, additional attachments and expansions for bicycles, wheelchairs and the transport of material.



### For individual persons

MPT turnstiles are the ideal solution when it is necessary to secure outdoor areas with high rates of pedestrian traffic. Numerous options are available for access control.



### Innovative drive technology

The MHTM™ drive unit (optional) is maintenance-free, energy-efficient, and has an exceptional soft-start action.

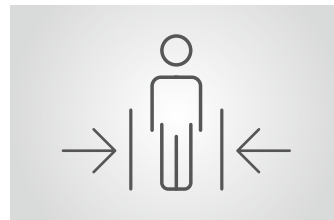

### Maximum safety

Low impact forces and sensitive contact detection offer optimum protection for users.



### Easy access to components

All the components necessary for operation are accommodated in the main beams, considerably simplifying assembly, commissioning and maintenance.

# MPT

## Turnstile

- > Reliable securing of outdoor areas and company grounds with high rates of pedestrian traffic
- > Mechanical, electromechanical or motorized designs available
- > Sensitive impact detection for maximum safety
- > Numerous options, e.g. expansion for wheelchair access
- > Designed for 10 million opening and closing actions



Technical data	MPT 132 3-wing	MPT 132 4-wing	MPT 33 3-wing	MPT 33 4-wing	MPT 30 3-wing	MPT 30 4-wing
Number of wings (angle)	3 (120°)	4 (90°)	3 (120°)	4 (90°)	3 (120°)	4 (90°)
Drive technology	MHTM™		electromechanical		mechanical	
Voltage	110 – 240 VAC, 50/60 Hz		110 – 240 VAC, 50/60 Hz		–	
Power consumption	approx. 50 W (without accessories)		approx. 50 W (without accessories)		–	
Duty cycle	100 %		100 %		–	
Enclosure rating	IP 43		IP 43		IP 43	
Dimensions (L x W x H)	1510 x 1288 x 2235 mm	1359 x 1076 x 2235 mm	1288 x 1500 x 2235 mm	1359 x 1076 x 2235 mm	1288 x 1500 x 2235 mm	1359 x 1076 x 2235 mm
Weight	approx. 250 kg	approx. 250 kg	approx. 250 kg	approx. 250 kg	approx. 250 kg	approx. 250 kg
Temperature range	–25 to +55°C		–25 to +55°C		–25 to +55°C	

### Options

Material	Galvanized steel, powder-coated steel in standard colors, powder-coated steel in special colors, stainless steel 14751
Reaction to power failure	Free access or auto-locking on power failure
Attachments	Extension column, illumination, base frame, base mounting set, roof, gate end display
Expansions	Controlled access for bicycles, wheelchairs and the transport of material (MPG 162)

### Potential applications



### Standard colors

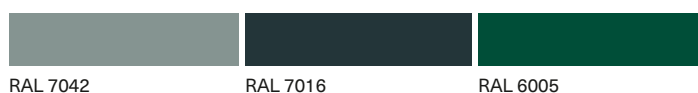

MPT 132/33/30 – 3-wing variants  
View from inside

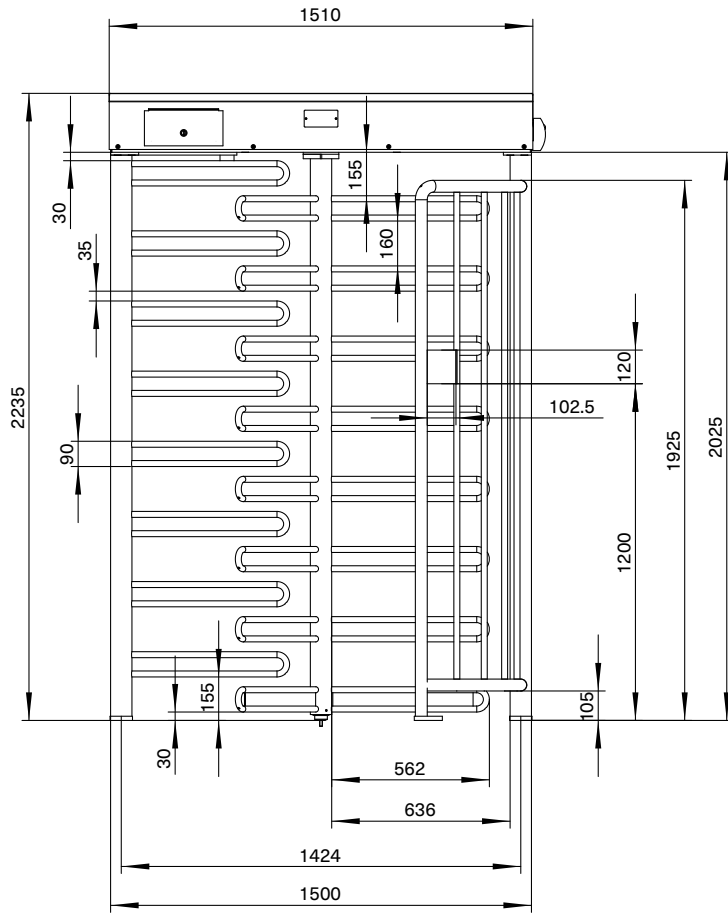

MPT 132/33/30 – 3-wing variants  
View from the side

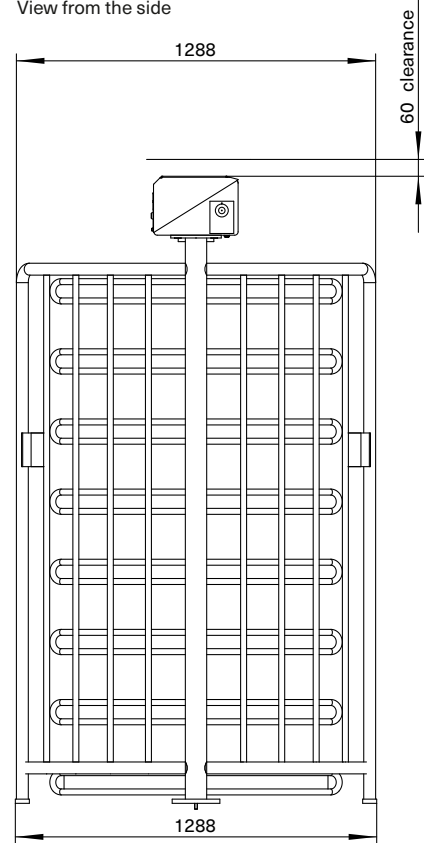

MPT 132/33/30 – 3-wing variants  
View from below

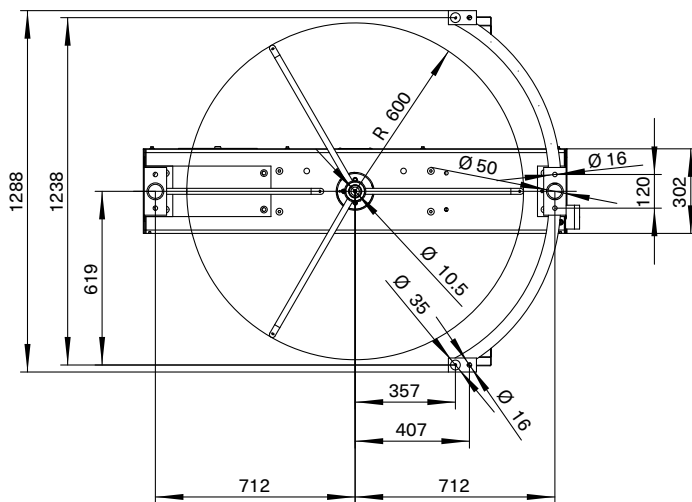

# Access to Progress

Magnetic stands for pioneering products – in every way. Our access control systems for vehicles or pedestrians clear the way for thousands of people every day – at car parks, toll gates, stations, airports and in buildings. Our technology is also pioneering, however: with innovative drives, intelligent control systems and well thought-out details it provides maximum safety and longevity. Are you also on the path to Magnetic?

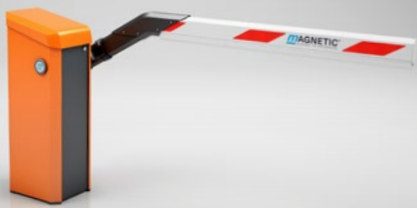

## Vehicle barriers

Access barriers  
Parking barriers  
Toll barriers  
Special barriers

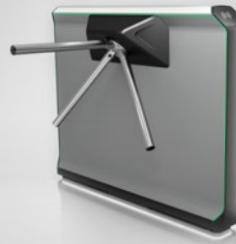

## Pedestrian gates

Turnstiles  
Swing gates  
Tripod gates  
Retractable gates  
Wing gates



## Terminals

Cars  
Trucks

*Germany*  
**MAGNETIC AUTOCONTROL GMBH**  
Grienmatt 20  
79650 Schopfheim  
Phone +49 7622 695-5  
Fax +49 7622 695-800  
E-mail [info@magnetic-germany.com](mailto:info@magnetic-germany.com)

*Australia*  
**MAGNETIC AUTOMATION PTY LTD**  
38 Metrolink Circuit  
Campbellfield, VIC 3061  
Phone +61 3 9339 2900  
E-mail [info@magnetic-oz.com](mailto:info@magnetic-oz.com)

*Austria*  
**FAAC GMBH**  
Münchner Bundesstraße 123  
5020 Salzburg  
Phone +43 662 853395-0  
E-mail [at.info@faacgroup.com](mailto:at.info@faacgroup.com)

*Benelux countries*  
**FAAC BENELUX NV/SA**  
Industriezone 3B  
8490 Jabbeke  
Belgium  
Phone +32 50 320202  
E-mail [info@magnetic-benelux.com](mailto:info@magnetic-benelux.com)

*Brazil*  
**MAGNETIC AUTOCONTROL LTDA**  
Av. Salim Antônio Curiati, 136  
04690-050 – São Paulo  
Phone +55 11 5660 8500  
E-mail [info@magnetic-br.com](mailto:info@magnetic-br.com)

*China*  
**MAGNETIC CONTROL SYSTEMS CO., LTD**  
No. 3 Building, No. 51  
Lane 1159, Kang Qiao (East) Road  
Kang Qiao Industrial Zone, Shanghai  
Phone +86 21 68182970  
E-mail [info@magnetic-cn.com](mailto:info@magnetic-cn.com)

*France*  
**FAAC FRANCE**  
377 Rue Ferdinand Perrier  
69808 St Priest Cedex  
Phone +33 4 72 21 86 89  
E-mail [info@magnetic-fr.com](mailto:info@magnetic-fr.com)

*India*  
**MAGNETIC AUTOCONTROL PVT LTD.**  
PRS Centre  
Plot No. 373 to 376, 2nd Floor (West Wing)  
1st Cross Street, Nehru Nagar  
Old Mahabalipuram Road  
Kottivakkam (Opp Rayala Technopark, Perungudi)  
Chennai 600041  
Phone +91 44 421 23297  
E-mail [info@magnetic-india.com](mailto:info@magnetic-india.com)

*Middle East*  
**FAAC MIDDLE EAST FZE**  
Dubai Silicon Oasis  
PO Box 54886  
Dubai  
United Arab Emirates  
Phone +971 4 3724193  
E-mail [info@magnetic-uae.com](mailto:info@magnetic-uae.com)

*N. and S. America (excl. Brazil)*  
**FAAC INTERNATIONAL, INC**  
3160 Murell Road  
Rockledge, FL 32955  
USA  
Phone +1 321 635 8585  
E-mail [info@magnetic-usa.com](mailto:info@magnetic-usa.com)

*Scandinavia*  
**FAAC NORDIC AB**  
Box 125  
284 22 Perstorp  
Sweden  
Phone +46 435 77 95 03  
E-mail [info@magnetic-nordic.com](mailto:info@magnetic-nordic.com)

*Southeast Asia*  
**MAGNETIC CONTROL SYSTEMS SDN. BHD**  
No. 17, Jalan Anggerik Mokara 31/54  
Taman Perindustrian Kota Kemuning  
40460 Shah Alam  
Selangor Darul Ehsan  
Malaysia  
Phone +60 3 5123 0033  
E-mail [info@magnetic-malaysia.com](mailto:info@magnetic-malaysia.com)